

## CHAPTER 1 – INTRODUCTION AND BACKGROUND

### Chapter Outline

- 1.1 Analog Integrated Circuit Design
- 1.2 Technology Impact on Analog IC Design
- 1.3 Analog Signal Processing
- 1.4 Notation, Symbology and Terminology
- 1.5 Summary

### Objectives

The objective of this course is to teach analog integrated circuit design using today's technologies and in particular, CMOS technology.

### Approach

1. Develop a firm background on technology and modeling
2. Present analog integrated circuits in a hierarchical, bottom-up manner
3. Emphasize understanding and concept over analytical methods (simple models)
4. Illustrate the correct usage of the simulator in design
5. Develop design procedures that permit the novice to design complex analog circuits (these procedures will be modified with experience)

### Organization (Second Edition of *CMOS Analog IC Design*)

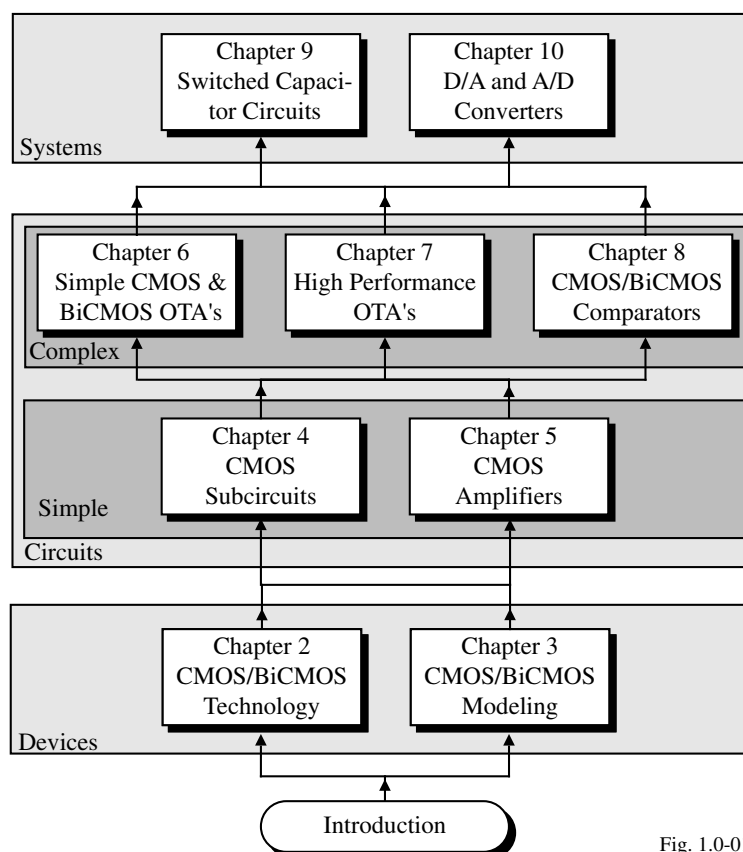

Fig. 1.0-01

## SECTION 1.1 - ANALOG INTEGRATED CIRCUIT DESIGN

### What is Analog IC Design?

Analog IC design is the successful implementation of analog circuits and systems using integrated circuit technology.

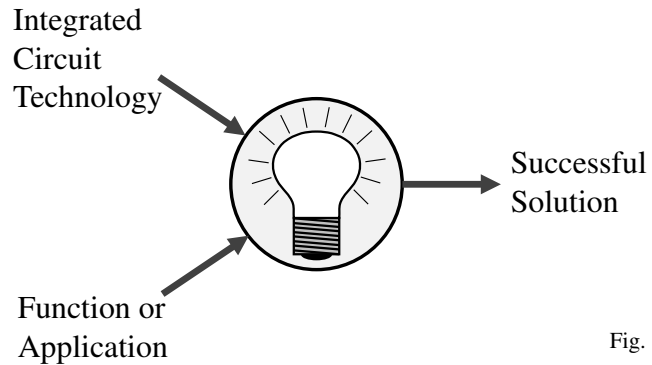

Fig. 1-1

### Unique Features of Analog IC Design

- Geometry is an important part of the design  
Electrical Design → *Physical Design* → Test Design
- Usually implemented in a mixed analog-digital circuit
- Analog is 20% and digital 80% of the chip area
- Analog requires 80% of the design time
- Analog is designed at the circuit level
- Passes for success: 2-3 for analog, 1 for digital

### The Analog IC Design Flow

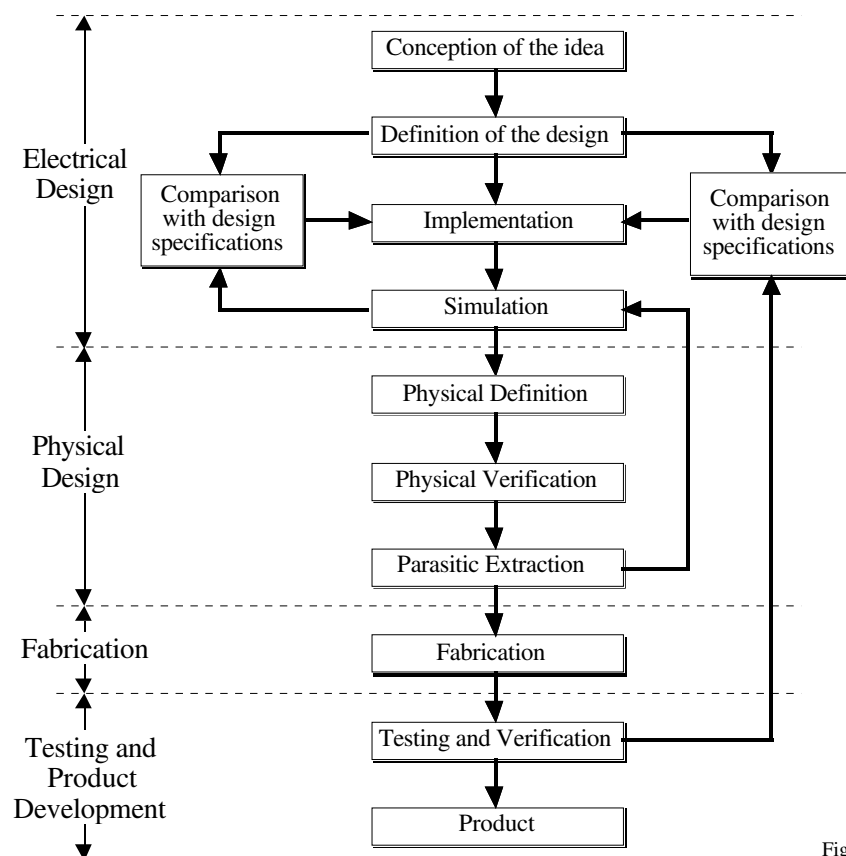

Fig. 1.1-2

## Analog IC Design - Continued

### • Electrical Aspects

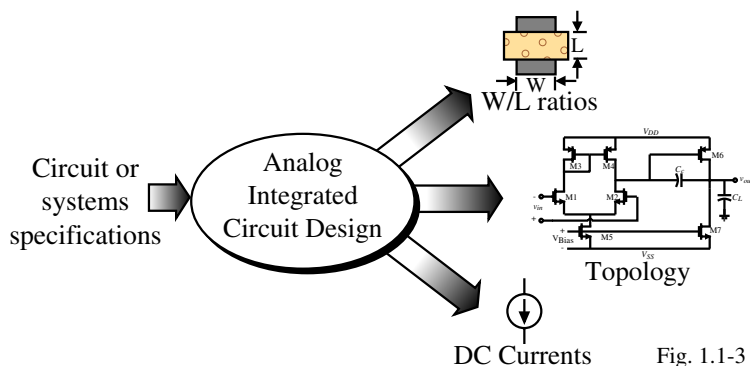

Fig. 1.1-3

### • Physical Aspects

Implementation of the physical design including:

- Transistors and passive components
- Connections between the above
- Busses for power and clock distribution
- External connections

### • Testing Aspects

Design and implementation for the experimental verification of the circuit after fabrication

## Comparison of Analog and Digital Circuits

Analog Circuits	Digital Circuits
Signals are continuous in amplitude and can be continuous or discrete in time	Signal are discontinuous in amplitude and time - binary signals have two amplitude states
Designed at the circuit level	Designed at the systems level
Components must have a continuum of values	Component have fixed values
Customized	Standard
CAD tools are difficult to apply	CAD tools have been extremely successful
Requires precision modeling	Timing models only
Performance optimized	Programmable by software
Irregular block	Regular blocks
Difficult to route automatically	Easy to route automatically
Dynamic range limited by power supplies and noise (and linearity)	Dynamic range unlimited

## Skills Required for Analog IC Design

- In general, analog circuits are more complex than digital
- Requires an ability to grasp multiple concepts simultaneously
- Must be able to make appropriate simplifications and assumptions
- Requires a good grasp of both modeling and technology
- Have a wide range of skills - breadth (analog only is rare)
- Be able to learn from failure
- Be able to use simulation correctly

Simulation “truths”:

- ◆ (Usage of a simulator) x (Common sense)  $\approx$  Constant
- ◆ Simulators are only as good as the models and the knowledge of those models by the designer
- ◆ Simulators are only good if you already know the answers

## SECTION 1.2 - TECHNOLOGY IMPACT ON ANALOG IC DESIGN

### Trends in CMOS Technology

- Moore’s law: The minimum feature size tends to decrease by a factor of  $1/\sqrt{2}$  every three years.
- Semiconductor Industry Association roadmap for CMOS

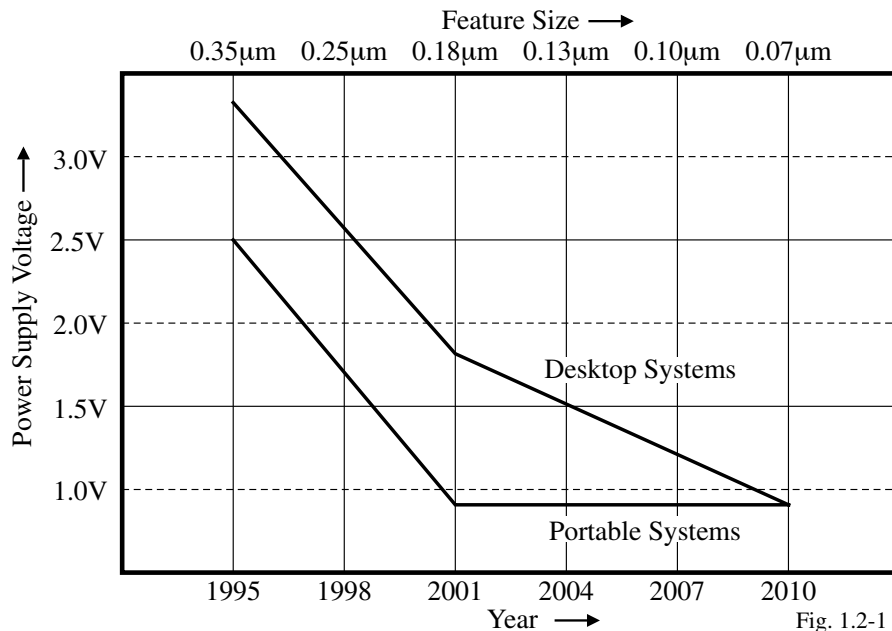
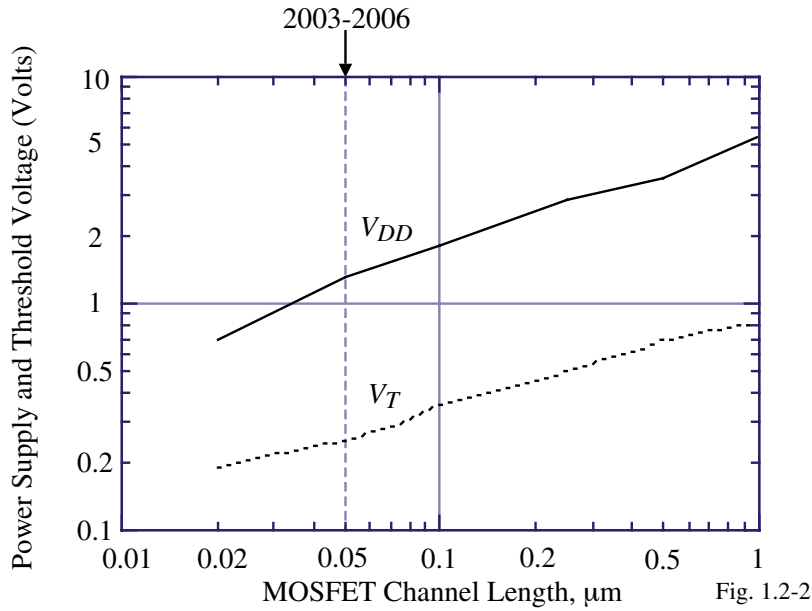

Fig. 1.2-1

### Trends in CMOS Technology - Continued

Threshold voltages and power supply:



### Trends in IC Technology

Technology Speed Figure of Merit vs. Time:

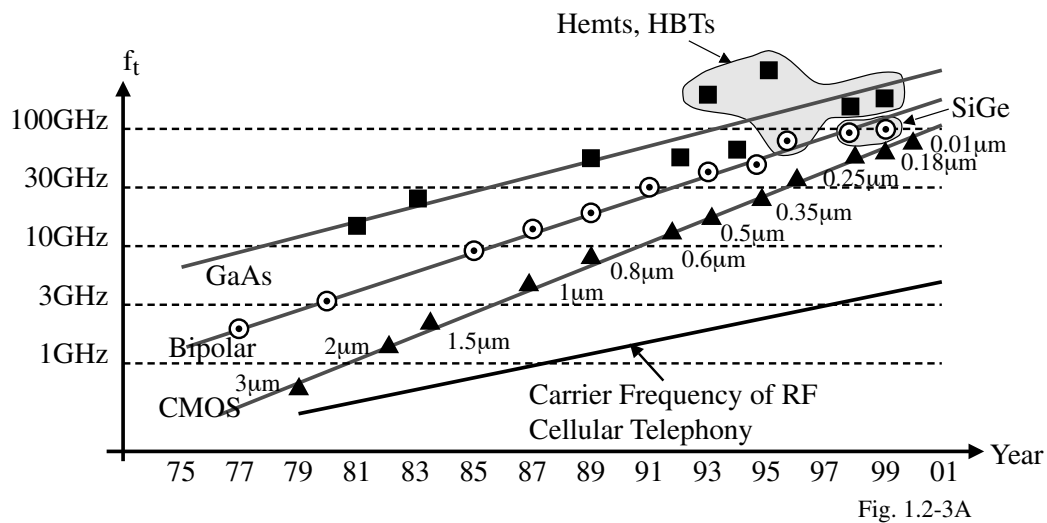

Estimated Frequency Performance based on Scaling:

Technology	$f_t$	$f_{max}$
0.35 micron	25GHz	40GHz
0.25 micron	40GHz	≈60-70GHz
0.18 micron	60GHz	≈90-100GHz

## Innovation in Analog IC Design

In the past, circuit innovation was driven by new technologies.

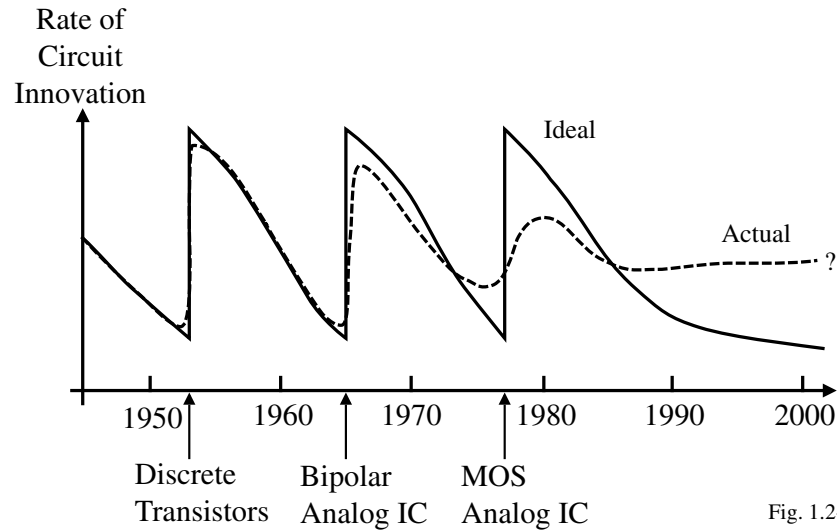

Fig. 1.2-4

Candidates for the 90's and 00's

- SiGe?
- Packaging?
- Opto-electronics?
- Vertically integrated transistors?

## Technology-Driven versus Application-Driven Innovation

Technology driven circuit innovation:

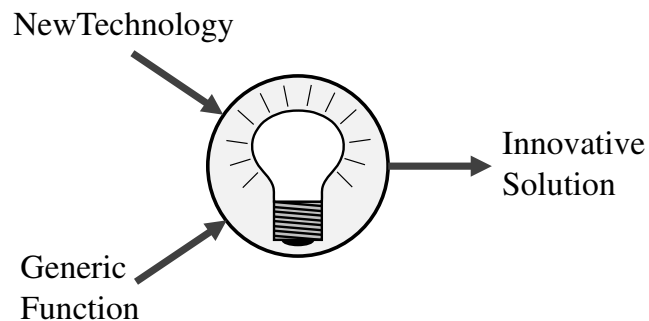

Application driven circuit innovation:

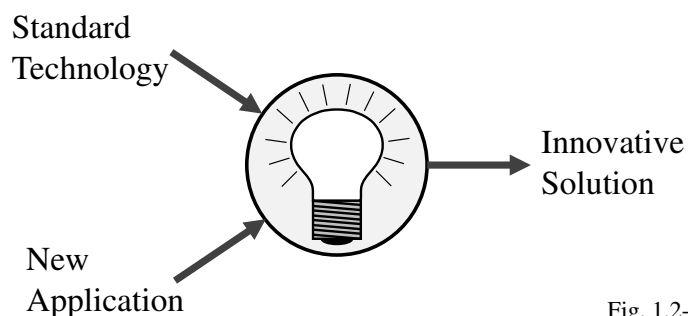

Fig. 1.2-5

## IC Design Development Time

A steeper ramp for the IC design development is required for every new generation of technology.

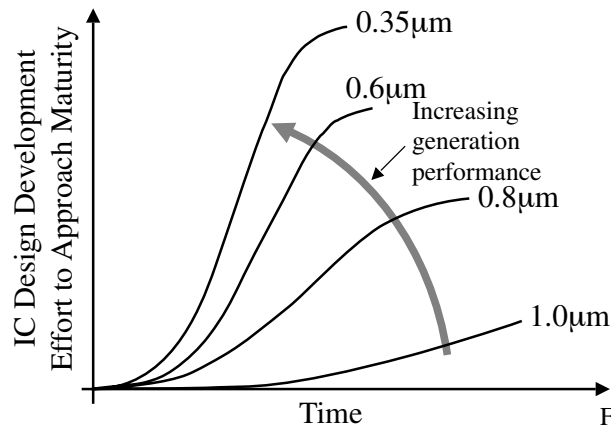

Fig. 1.2-6

Results:

- Scramble to develop new tools
- Complexity is increasing with each new scaling generation
- Need more trained and skilled circuit designers

## Implications of Technology on IC Design

The good:

- Smaller geometries
- Smaller parasitics
- Higher transconductance
- Higher bandwidths

The bad:

- Reduced voltages
- Smaller channel resistances (lower gain)
- More nonlinearity
- Deviation from square-law behavior

The ugly:

- Increased substrate noise in mixed signal applications
- Threshold voltages are not scaling with power supply
- Reduced dynamic range
- Suitable models for analog design

## SECTION 1.3 - ANALOG SIGNAL PROCESSING

### Signal Bandwidths versus Application

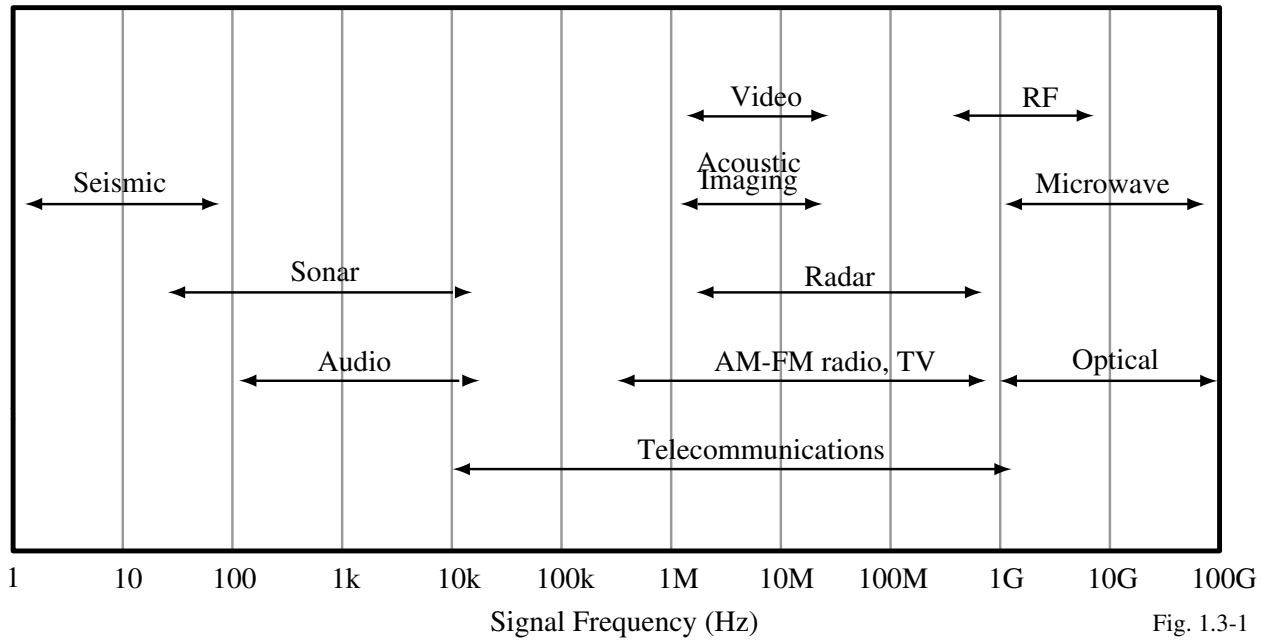

Fig. 1.3-1

### Signal Bandwidths versus Technology

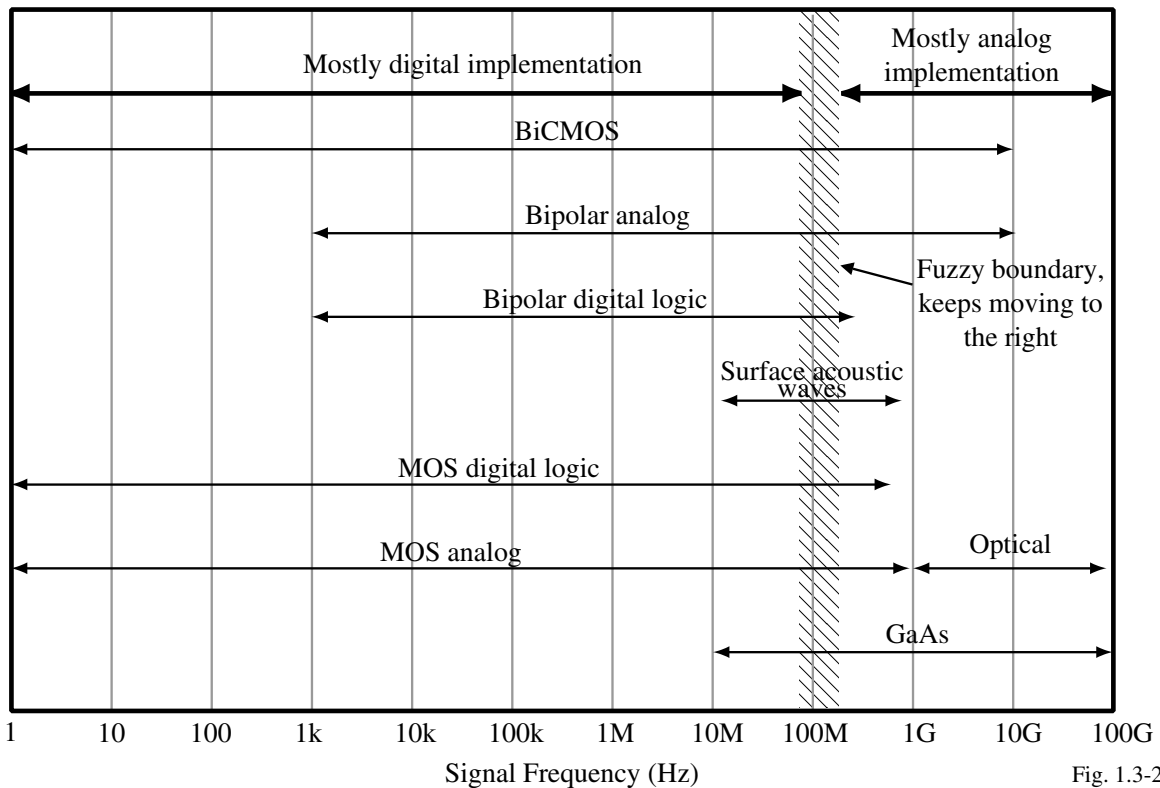

Fig. 1.3-2



## **Analog IC Design has Reached Maturity**

There are established fields of application:

- Digital-analog and analog-digital conversion
- Disk drive controllers
- Modems - filters
- Bandgap reference
- Analog phase lock loops
- DC-DC conversion
- Buffers
- Codecs
- 
- 
- 

Existing philosophy regarding analog circuits:

“If it can be done economically by digital, don’t use analog.”

Consequently:

Analog finds applications where speed, area, or power have advantages over a digital approach.

## **Eggshell Analogy of Analog IC Design (Paul Gray)**

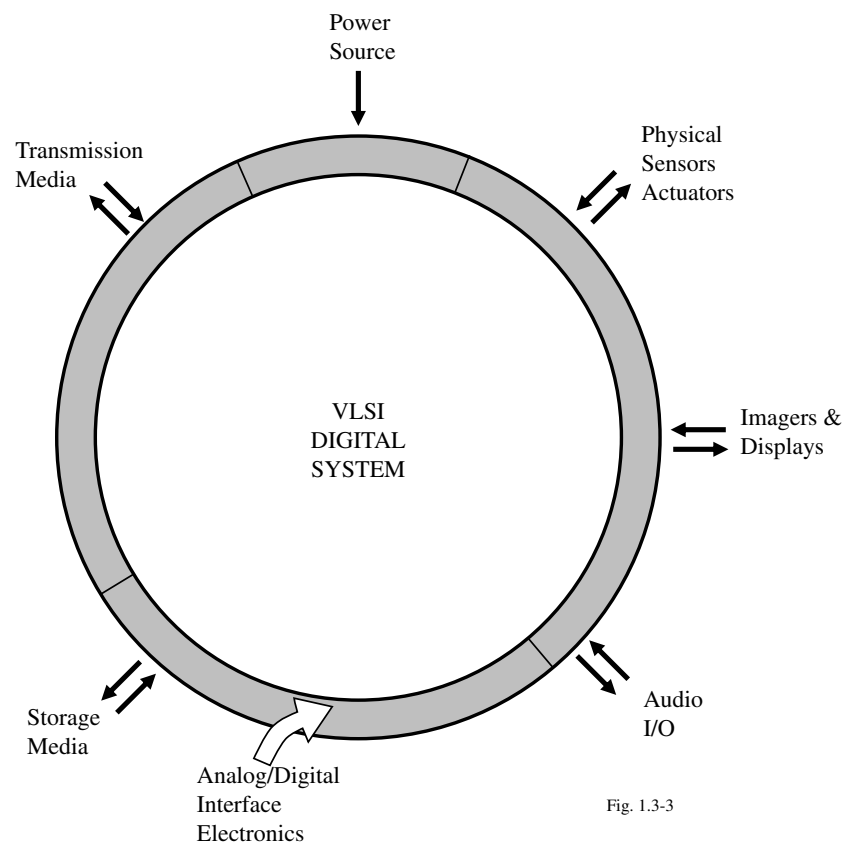

Fig. 1.3-3

## **Analog Signal Processing versus Digital Signal Processing in VLSI**

Key issues:

Analog/Digital mix is application dependent

Not scaling driven

Driven by system requirements for  
programmability/adaptability/testability/designability

Now:

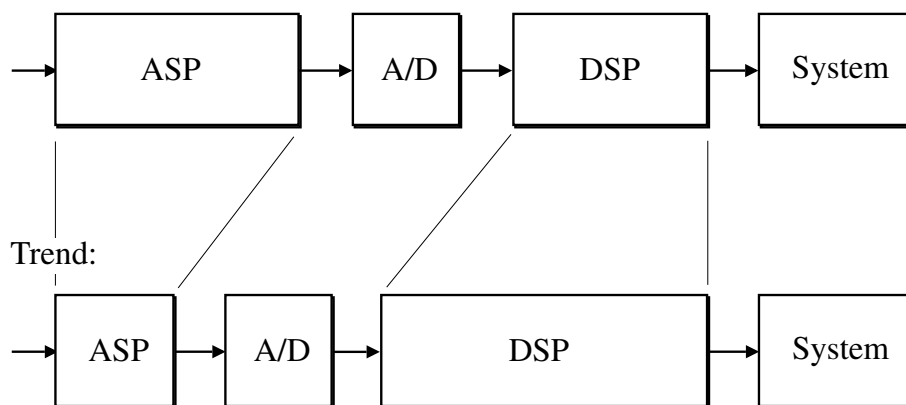

Fig. 1.3-4

## **Application Areas of Analog IC Design**

There are two major areas of analog IC design:

- Restitutive - performance oriented (speed, accuracy, power, area)

Classical analog circuit and systems design

- Cognitive - function oriented (adaptable, massively parallel)

A newly growing area inspired by biological systems

Analog VLSI (An oxymoron):

Combination of analog circuits and VLSI philosophies

- Many similarities between analog circuits and biological systems

Scalability

Nonlinearity

Adaptability

- Neuromorphic analog VLSI

Use of biological systems to inspire circuit design such as smart sensors and imagers

- Smart autonomous systems

Self-guided vehicles (Mars lander)

Industrial cleanup in a hazardous environment

- Sensorimotor feedback

Self contained systems with sensor input, motor output

## What is the Future of Analog IC Design?

- Technology will require more creative circuit solutions in order to achieve desired performance
- Analog circuits will continue to be a part of large VLSI digital systems
- Interference and noise will become even more serious as the chip complexity increases
- Packaging will be an important issue and offers some interesting solutions
- Analog circuits will always be at the cutting edge of performance
- Analog designer must also be both a circuit and systems designer and must know:
  - Technology and modeling
  - Analog circuit design
  - VLSI digital design
  - System application concepts
- There will be no significantly new and different technologies - innovation will combine new applications with existing or improved technologies
- Semicustom methodology will eventually evolve with CAD tools that will allow:
  - Design capture and reuse
  - Quick extraction of model parameters from new technology
  - Test design
  - Automated design and layout of simple analog circuits

## SECTION 1.4 - NOTATION, SYMBOLOGY, AND TERMINOLOGY

### Definition of Symbols for Various Signals

Signal Definition	Quantity	Subscript	Example
Total instantaneous value of the signal	Lowercase	Uppercase	$q_A$
DC value of the signal	Uppercase	Uppercase	$Q_A$
AC value of the signal	Lowercase	Lowercase	$q_a$
Complex variable, phasor, or rms value of the signal	Uppercase	Lowercase	$Q_a$

Example:

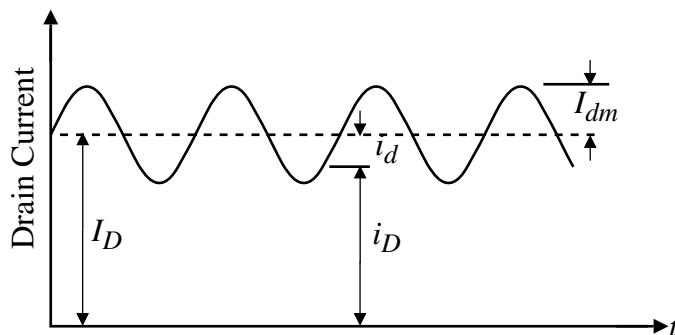
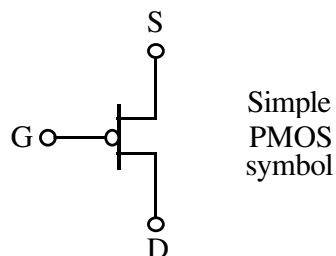
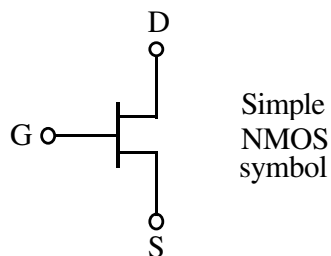
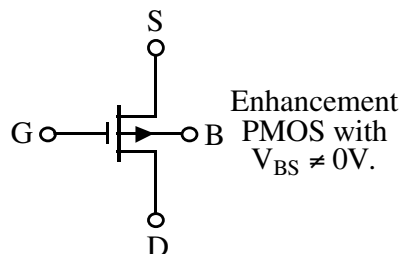
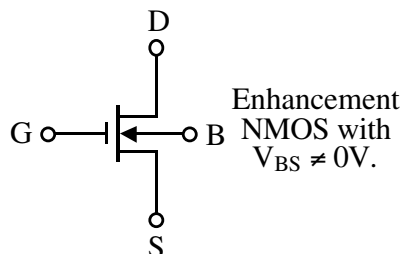
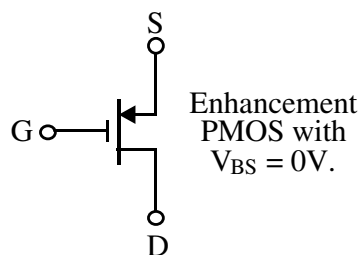
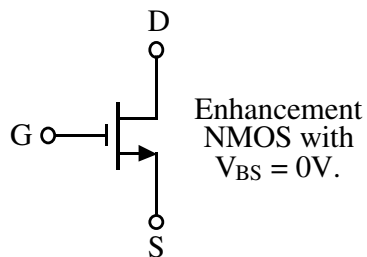
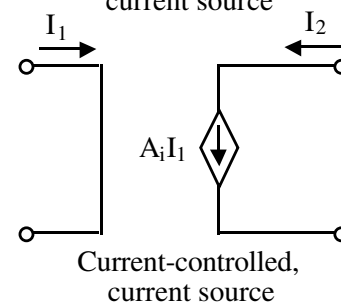
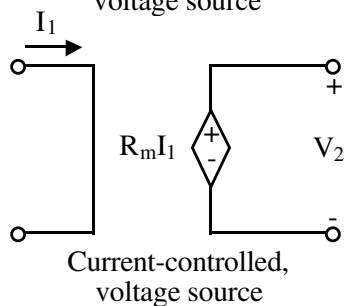
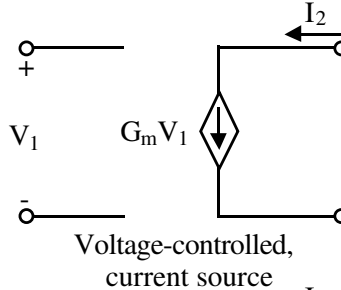
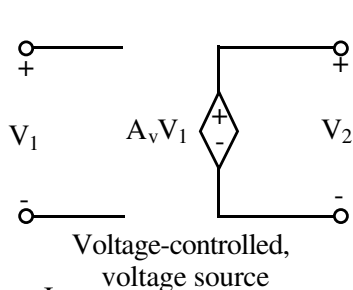
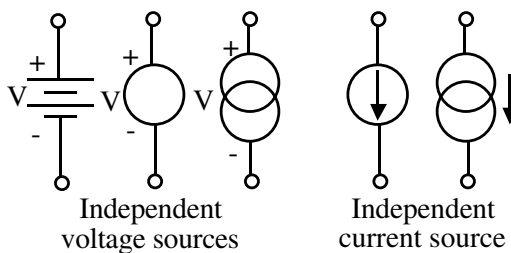
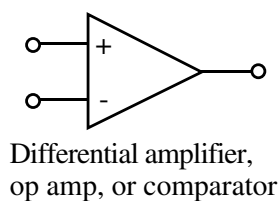

Fig. 1.4-1

### MOS Transistor Symbols



### Other Schematic Symbols



### Three-Terminal Notation (Data books)

#### $Q_{ABC}$

$A$  = Terminal with the larger magnitude of potential

$B$  = Terminal with the smaller magnitude of potential

$C$  = Condition of the remaining terminal with respect to terminal  $B$

$C = 0 \Rightarrow$  There is an infinite resistance between terminal  $B$  and the 3rd terminal

$C = S \Rightarrow$  There is a zero resistance between terminal  $B$  and the 3rd terminal

$C = R \Rightarrow$  There is a finite resistance between terminal  $B$  and the 3rd terminal

$C = X \Rightarrow$  There is a voltage source in series with a resistor between terminal  $B$  and the 3rd terminal in such a manner as to reverse bias a PN junction.

#### Examples

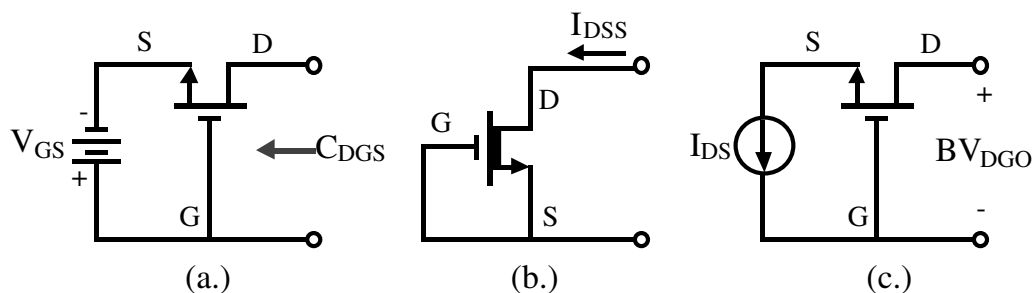

(a.) Capacitance from drain to gate with the source shorted to the gate.

(b.) Drain-source current when gate is shorted to source (depletion device)

(c.) Breakdown voltage from drain to gate with the source is open-circuited to the gate.

### 1.5 - SUMMARY

- Analog IC design combines a function or application with IC technology for a successful solution.
- Analog IC design consists of three major steps:
  - 1.) Electrical design  $\Rightarrow$  Topology, W/L values, and dc currents
  - 2.) Physical design (Layout)
  - 3.) Test design (Testing)
- Analog designers must be flexible and have a skill set that allows one to simplify and understand a complex problem
- Analog IC design is driven by improving technologies rather than new technologies.
- Analog IC design has reached maturity and is here to stay.
- The appropriate philosophy is “If it can be done economically by digital, don’t use analog”.
- As a result of the above, analog finds applications where speed, area, or power have advantages over a digital approach.
- Deep-submicron technologies will offer severe challenges to the creativity of the analog designer.